

IULOCK

IU-20 SMART DOOR KNOB Installation and User Guide V3.8

Required tools (not included)

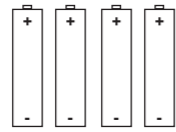
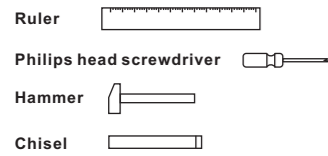

Lock Components

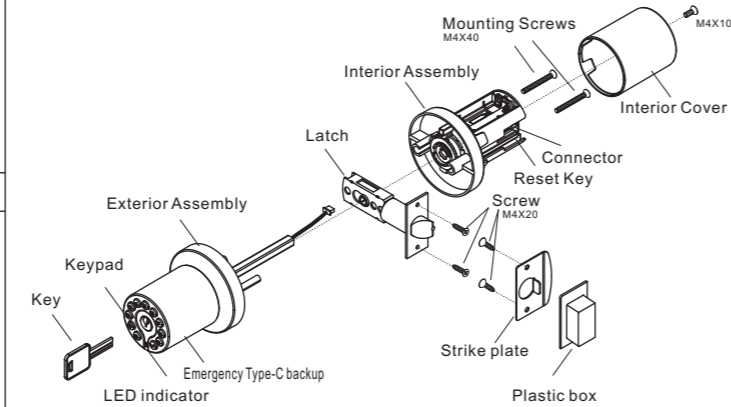

1. Prepare the door and check dimensions

Use template to mark holes

Drill two holes

Check dimensions

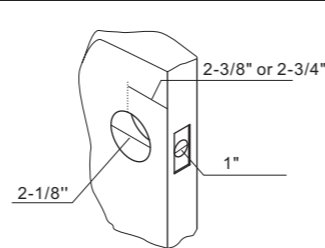
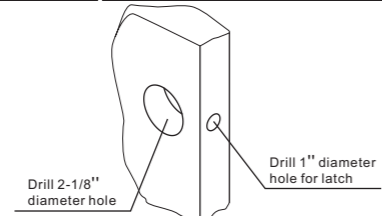
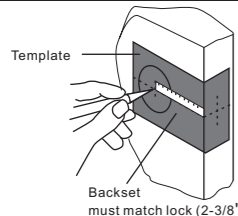

Measure your door for a backset of the 2-3/8" or 2-3/4". If it is 2-3/4", adjust the latch as follows:
Grasp the spring pin and move it from the 2-3/8" slot to 2-3/4" slot.
If the spindle holes of the latch are not aligned, repeat the 2-3/8" and 2-3/4" positions. This will automatically align the latch spindle holes.

2. Install the latch and strike plate

Setting latch (60MM or 70MM)

Install latch

Install strike plate

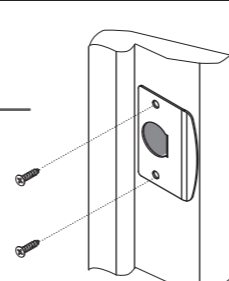
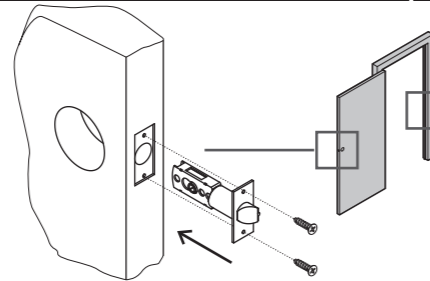
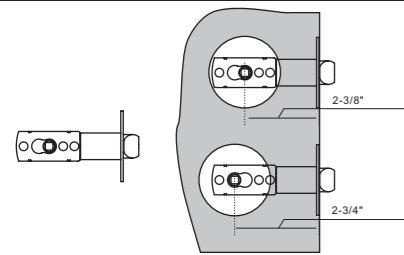

3. Install the exterior keypad and the interior assembly

Install the exterior keypad

Install the interior assembly

Pull out the power cable

Pay attention to "THIS SIDE UP" on the spindle

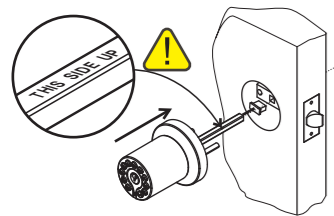

Align the exterior keypad with the bore hole. Feed the power cable through latch. The spindle on the exterior keypad should be aligned with the hole in the center of the latch. Insert the spindle through this hole as you press the exterior keypad against the door.

feed power cable through hole in knob and guide spindle into knob.

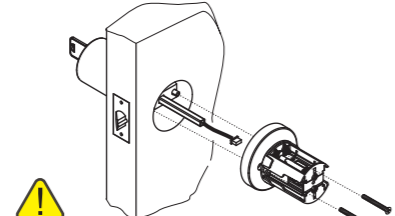

After tightening the 2 fixing screws, the knob should be easily turned by hand. After your hand leaves the inside knob, the inside knob should easily return to the original position. If not, please re-adjust the position of the inside knob and tighten the screw.

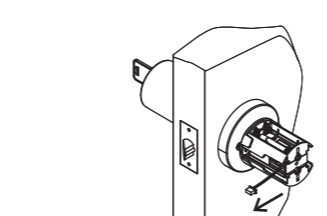

Do not pull the power cable too hard

4. Install the batteries and perform the door handing process

5. Install the interior cover

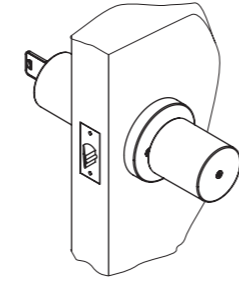
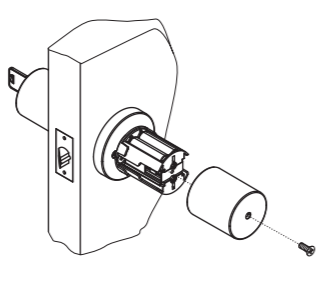
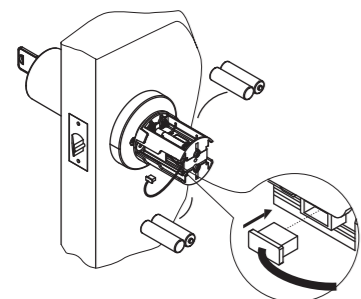

Features

- two ways to access: code and key
- 22 F to +176 F temperature range
- Low power consumption, 4 AA for 2 Years Battery Life or 20,000 times unlock
- Backlit keypad for use in low light environments
- 1 master code and 50 user codes
- Passage mode for hassle-free entry
- Built-in disguise feature to protect your codes from prying eyes
- Low battery warning indication

Keypad

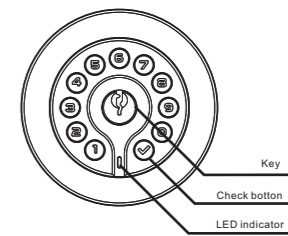

Programming guide

Indicator light signals and beep

The color of the light indicates & beep, the status of the lock.

Green

- a correct master passcode or user passcode was entered, one long beep
- the programming process is complete, one long beep

Red

- an incorrect master passcode or user passcode was entered, three short beep
- there was an error in programming, three short beep
- red blinking and beep after keypad backlight off indicates critically low battery

Unlock with passcode

ENTER	PRESS
master code or user code	

Green and one long beep

Code correct, you can turn the knob to open the door immediately, and it will be automatically locked later (the automatic locking time depends on the setting of the automatic locking timer, the default is 4 seconds).

Red and three short beeps

The code is incorrect, please re-enter the correct code and press the check button to confirm

Passcode and Passcode Disguise

Master passcode

- The master code MUST EXIST and can be modified, but cannot be deleted.
- The lock comes preset with default master passcode 123456.
- Make sure to set a new master code which can be 1-15 digits long as soon as you finish installing the lock.
- Used to put the lock in programming mode.
- Can unlock the lock.
- Must be different from all of the User Codes currently in the lock.
- If you forget the master passcode, you may reset the lock to factory settings, which restores the default master passcode. Please see Restore Factory Settings.

User passcode

- User codes can be added, modified, deleted.
- Can be 1-15 digits long.
- The lock comes preset with no user codes.
- Used to unlock the lock.
- Must be different from the master passcode and other user passcodes.
- Up to 50 possible user codes can be stored in the lock at one time.

Passcode Disguise

This function is an added security feature which is aimed at preventing passcode theft. With Passcode Disguise, you may enter up to 40 digits into the keypad. As long as the correct passcode sequence is entered, regardless of how many digits were entered before or afterwards, the lock will unlock. For example, if your user passcode is "112256", you can successfully unlock the lock by entering "****112256****" (limit 40 digits).

Unlock with key

Insert the key and rotate the key. The first quarter turn should be very easy, then continue to turn the key to retract the latch and you may need to apply some force.

Tips: Turning the handle with the other hand in the same direction while you are turning the key will make it easier to open.

Note: Because the knob is relative heavy and the mechanical key of this electronic door knob is completely independent, so using the key requires a little more force than the common mechanical lock.

Immediate Lock

Press the check button 4 times in a row at any time and the door will be immediately locked, which overrides any other working modes.

Restore Factory Settings

To delete all user codes, including the master code, follow the instructions below:

- Use a screwdriver to remove the screws from the interior cover.
- Remove the cover and find the reset button located on the battery pack.
- Press and hold the reset button for 7 seconds until long beep are heard. The master passcode will return to the manufacturer default code '123456'.

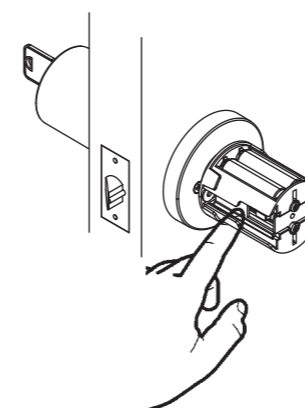

Change your master code immediately when you finish restoring the factory settings.

Mobile remote code

The code is generated by the website. You can set the unlock times or unlock time periods on the website page. If it exceeds the set number of times or time period, it will become invalid automatically. You do not need to program locks. Therefore, you can remotely authorize this remote code to your relatives, friends, neighbors, hourly workers, classmates or employees to enter your home, room or office.

Please visit mylock.iulock.com or scan the QR code below to access the website.

- Register account
- Add lock
- Activate your lock
- Use remote code

For remote code instructions, please visit www.iulock.com



Programming

» If you make a mistake during programming, press the check button repeatedly until the keypad lights up. Then start over.

PASSCODE

ADD USER PASSCODE									
Press	Press	Press	Enter	Press	Enter	Press	Enter same	Press	
✓	①	✓	Master passcode	✓	New user passcode	✓	New user passcode	✓	
Note : The New User Passcode must be different from all of the Passcodes currently in the lock.									
CHANGE MASTER PASSCODE									
Press	Press	Press	Enter	Press	Enter same	Press	Enter	Press	Enter same
✓	②	✓	Master passcode	✓	master passcode	✓	New master passcode	✓	New master passcode
⚠ Note : The master code MUST EXIST in the lock and cannot be deleted, but can ONLY be changed.									
CHANGE USER PASSCODE									
Press	Press	Press	Enter	Press	Enter	Press	Enter	Press	Enter same
✓	②	✓	Master passcode	✓	Unwanted user passcode	✓	New user passcode	✓	New user passcode
Note : The New user passcode must be different from all of the passcodes currently in the lock.									
DELETE A USER PASSCODE									
Press	Press	Press	Enter	Press	Enter	Press			
✓	③	✓	Master passcode	✓	Unwanted user passcode	✓			
DELETE ALL USER PASSCODES									
Press	Press	Press	Enter	Press					
✓	④	✓	Master passcode	✓					
⚠ Note : The master code cannot be deleted, but can ONLY be changed.									

PASSCODE

BEEPER

DISABLE BEEPER						
Press	Press	Press	Enter	Press	Press	Press
✓	⑥	✓	Master passcode	✓	①	✓
ENABLE BEEPER						
Press	Press	Press	Enter	Press	Press	Press
✓	⑥	✓	Master passcode	✓	①	✓

The beeper can be turned off if desired.
Beeper will still sound to indicate a low battery.

BEEPER

PASSAGE

EASY PASSAGE MODE						
Press	Press	Press	Enter	Press		
✓	⑤	✓	Master passcode	✓		
With EASY PASSAGE MODE active, the door will stay unlocked. Press any button to turn off this function when it is no longer needed.						
ADVANCED PASSAGE MODE						
Press	Press	Press	Enter	Press	Press	Press
✓	①	✓	Master passcode	✓	①	✓
With ADVANCED PASSAGE MODE active, open the door by twisting door handle directly. Turn off this mode only by entering master code and check key. * Press the check button 4 times in a row, the door will be immediately locked, which overrides any working modes.						

PASSAGE

ADVANCED

AUTO-LOCK MODE						
Press	Press	Press	Enter	Press	Press	Press
✓	①	✓	Master passcode	✓	①	✓
In AUTO-LOCK MODE, the door will automatically lock after each unlocking, the auto-lock time depends on the setting of the auto-lock timer. * Press the check button 4 times in a row, the door will be immediately locked, which overrides any working modes.						
MANUAL-LOCK MODE						
Press	Press	Press	Enter	Press	Press	Press
✓	①	✓	Master passcode	✓	②	✓
In MANUAL LOCK MODE, the auto-lock will turn off. After unlocking the door with a passcode or fingerprint, it will remain unlocked until any button is pressed.						
SET AUTO-LOCK TIMER						
Press	Press	Press	Enter	Press	Press	Press
✓	⑨	✓	Master passcode	✓	③	✓
The automatic lock time unit is seconds. Minimum is 2 seconds. Maximum is 43200 seconds (12 hours). Default is 4 seconds.						

ADVANCED

REMOTE

ACTIVATE REMOTE CODE FEATURE						
Press	Press	Press	Enter	Press	Enter	Press
✓	⑧	✓	Master passcode	✓	Activate code	✓
The activate code is generated by the website.(www.mylock.iulock.com) Deactivate remote code function when the activate code is 0.						

REMOTE

Troubleshooting

www.iulock.com

24hr online service

I cannot insert the spindle into the latch hole, because of the 2 sides of the spindle hole of the latch are not aligned?
Let the hole parts move a few times in the 2-3/8 and 2-3/4 positions and the spindle holes of the latch will automatically align.

Why is it beeping after keypad light off?
The battery may be low. Please replace the battery.

The lock doesn't work?
Try replacing the battery or using the backup battery. If the lock still does not work, contact customer support.

Why can't I open the door?
You may be waiting too long to open the door. After entering a code, turn the handle to open the door while the lock LED indicator light is green. Once the LED indicator light is off, the lock will return to locked position immediately.

Why I can open without passcode?
You maybe active the passage mode, use master code access will turn off this function.
If you just installed it, make sure the "THIS SIDE UP" on the spindle is facing up (ceiling).

I forgot all my codes.
The lock must undergo a hard reset in order to set the master code back to default and erase all other codes. In order to perform a hard reset, please refer to the above "Restore Factory Settings".

If none of the above information resolves your issue, please visit our website at: www.iulock.com

Warranty

Lifetime Limited Mechanical and Finish Warranty and 1-Year Limited Electronics Warranty Subject to the terms and conditions of the warranty, IULOCK extends a lifetime limited mechanical and finish warranty and a one-year limited electronics warranty to the original consumer user ("Original User") of our IULOCK brand product ("Product") against defects in material and workmanship, as long as the Original User occupies the residential premises upon which the Product was originally installed. See answers www.iulock.com for specific warranty details and limitations

Important Safeguards

1. Read all instructions in their entirety.
2. Familiarize yourself with all warning and caution statements.
3. Remind all family members of safety precautions.
4. Protect your user passcode and master passcode.
5. Dispose of used batteries according to local laws and regulations.

⚠ WARNING:

This Manufacturer advises that no lock can provide complete security by itself. This lock maybe defeated by forcible or technical means, or evaded by entry elsewhere on the property. No lock can substitute for caution, awareness of your environment, and common sense. Builder's hardware is available in multiple performance grades to suit the application. In order to enhance security and reduce risk, you should consult a qualified locksmith or other security professional.

Template

