

IU-KNOB

IU-32 DOUBLE KEYPAD DOOR KNOB Installation and User Guide

Required tools (not included)

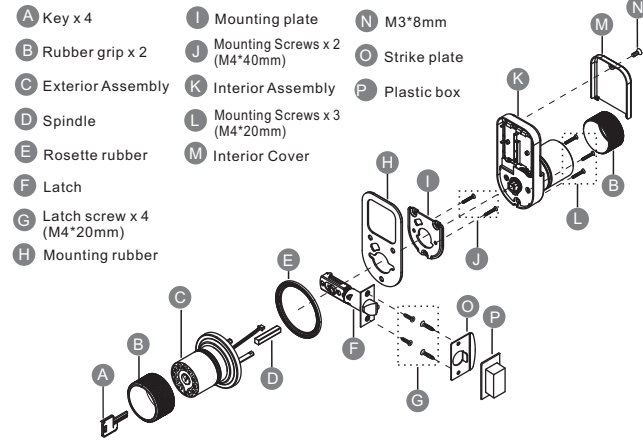
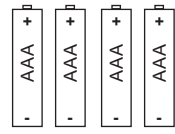
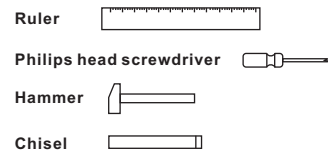

- A Key x 4
- B Rubber grip x 2
- C Exterior Assembly
- D Spindle
- E Rosette rubber
- F Latch
- G Latch screw x 4 (M4*20mm)
- H Mounting rubber
- I Mounting plate
- J Mounting Screws x 2 (M4*40mm)
- K Interior Assembly
- L Mounting Screws x 3 (M4*20mm)
- M Interior Cover
- N M3*8mm
- O Strike plate
- P Plastic box

1 Prepare the door and check dimensions >>

Install the latch and strike plate

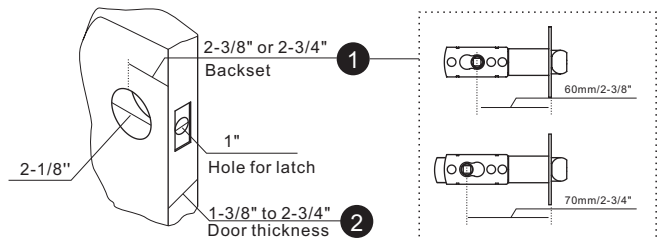

- 1 Measure your door for a backset of the 2-3/8" or 2-3/4". If it is 2-3/4", adjust the latch as follows: Grasp the spring pin and move it from the 2-3/8" slot to 2-3/4" slot.
- 2 Confirm the door is between 1-3/8" to 2-3/4" thick.

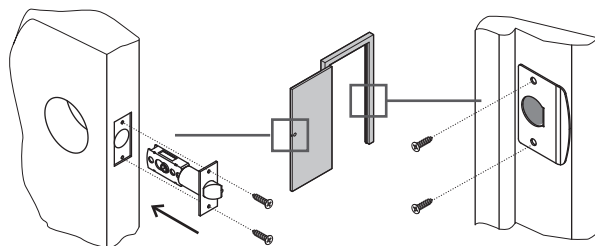

2 Install the rosette rubber >>

Install the spindle >>

Insert the exterior keypad >>

Install the mounting plate

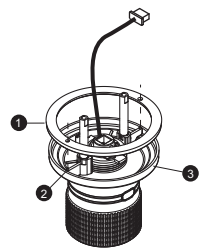

Align the rubber(gasket)(1) with the two protrusions(2) of the rosette(3), then press the rubber(gasket)(1) along the edge of the rosette(3).

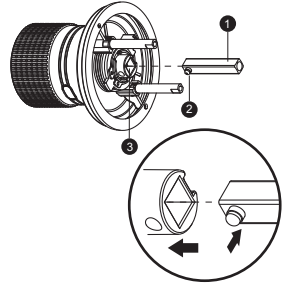

Press the protrusion(2) of the spindle(1) and push it into the keyway(3) of the exterior assembly.

For doors thicker than 2", please use additional option spindles.

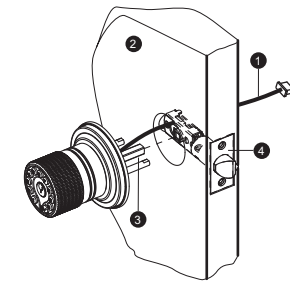

Align the exterior keypad with the hole of the door(2). Thread the power cable(1) through the hole of the door(2) and make sure it is above the latch(4). The spindle(3) on the exterior keypad should be aligned with the hole in the center of the latch. Insert the spindle(3) through this hole as you press the exterior keypad against the door.

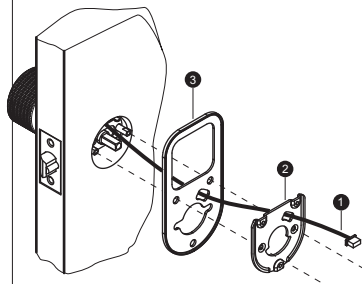

Thread the power cable(1) through the hole of the mounting rubber(3) and the mounting plate(2) in turn.

3 Fix the mounting plate >>

Connect the power cable >>

Install the interior keypad >>

Install the batteries and cover

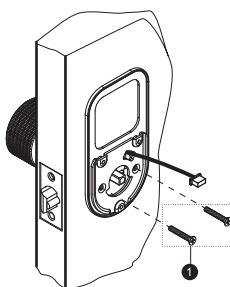

Tighten the two mounting screws(1) evenly.

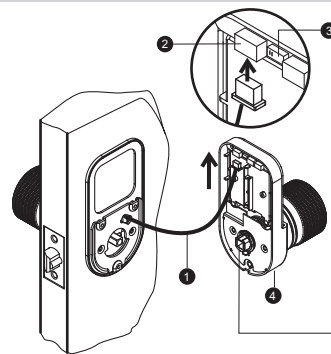

Plug the power cable(1) into the connector(2) of the interior assembly(4).

Set the SYNC switch(3) Please refer to Synchronize Passcode.

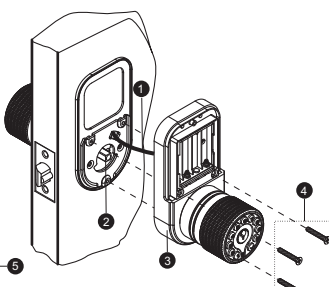

Align the interior assembly(3) with the spindle(2). Press the interior assembly(3) against the door. Make sure the power cable(1) do not get stuck by the interior assembly(3), then tighten the three mounting screws(4) evenly.

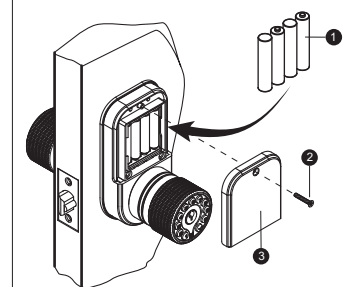

Install the batteries(1) and the interior cover(3). Then tighten the screw(2).

Specifications

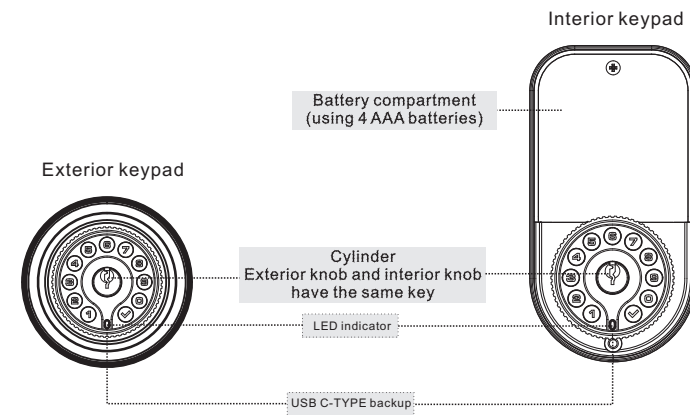

- Two ways to access: code or key.
- 22 F to +176 F temperature range.
- Low power consumption, 4 AAA for 1 Year Battery Life or 10,000 times unlock.
- Backlit keypad for use in low light environments.
- 1 master code, 50 user codes (each knob).
- Built-in mobile remote code.
- Passage mode for hassle-free entry.
- Programmable Auto-lock mode or Manual-lock mode.
- Low battery warning indication.

Indicator light signals and beep

The color of the light indicates & beep, the status of the lock.

Green

- A correct master passcode or user passcode was entered, one long beep
- The programming process is complete, one long beep

Red

- An incorrect master passcode or user passcode was entered, three short beeps
- There was an error in programming, three short beeps
- red blinking and beep after keypad backlight off indicates critically low battery

Synchronize Passcode

Code synchronization is designed for convenience of passcode settings of double keypad.

Sync Switch

When the switch is in the sync position
Any changing passcode settings on any keypad will be synchronized to another keypad. Synchronization is only applicable to change the passcodes and reset the lock.

When the switch is not in the sync position
The exterior keypad and the interior keypad are completely independent. The settings and reset of the two keypads do not affect each other.

Back of interior assembly

Passcode

Master passcode

- The master code MUST EXIST and can be modified, but cannot be deleted.
- The lock comes preset with default master passcode 123456. Make sure to set a new master code which can be 1-15 digits long as soon as you finish installing the lock.
- Used to put the lock in programming mode.
- Can unlock the lock.
- Must be different from all of the User Codes currently in the lock.
- If you forget the master passcode, you can reset the lock to factory settings, which restores the default master passcode. For more information, please see Restore Factory Settings.

User passcode

- User codes can be added, modified, deleted.
- Can be 1-15 digits long.
- The lock comes preset with no user codes.
- Used to unlock the lock.
- Must be different from the master passcode and other user passcodes.
- Up to 50 possible user codes can be stored in the lock at one time.

Passcode Disguise

This function is an added security feature which is aimed at preventing passcode theft. With Passcode Disguise, you may enter up to 40 digits into the keypad. As long as the correct passcode sequence is entered, regardless of how many digits were entered before or afterwards, the lock will unlock. For example, if your user passcode is "112256", you can successfully unlock the lock by entering "*****112256*****" (limit 40 digits).

Unlock with passcode

ENTER	PRESS
master code or user code	✓

Green and one long beep

Code correct, you can turn the knob to open the door immediately, AUTO-LOCK MODE
It will be automatically locked later (the automatic locking time depends on the setting of the automatic locking timer, the default is 4 seconds). MANUAL-LOCK MODE
It will remain unlocked until any button is pressed.

Red and three short beeps

The code is incorrect, please re-enter the correct code and press the check button to confirm.

Mobile remote code

The code is generated by the website. You can set the unlock times or unlock time periods on the website page. If it exceeds the set number of times or time period, it will become invalid automatically. You do not need to program locks. Therefore, you can remotely authorize this remote code to your relatives, friends, neighbors, hourly workers, classmates or employees to enter your home, room or office.

Please visit mylock.iulock.com or scan the QR code below to access the website.



1. Register account.
2. Add lock (Serial number of the lock).
3. Activate your lock.
4. Use remote code.

For remote code instructions, please visit www.iulock.com

Restore Factory Settings

To delete all user codes, including the master code, follow the instructions below:

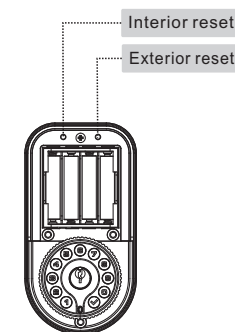

1. Use a screwdriver to remove the screws from the interior cover.
2. Remove the cover and find the reset button located on the battery pack.
3. Press and hold the reset button for 7 seconds until a long beep is heard. The master passcode will return to the manufacturer default code "123456".

Settings	Default
Master code	123456
User code	Not preset
Beeper	Enable
Passage mode	Disable
Lock mode	Auto-lock mode
Auto-lock timer	4 seconds
Remote code	Deactivated

Programming

»If you make a mistake during programming,press the check button repeatedly until the keypad lights up. Then start over.

PASSCODE	ADD USER PASSCODE									
	Press	Press	Press	Enter	Press	Enter	Press	Enter same	Press	
	✓	①	✓	Master passcode	✓	New user passcode	✓	New user passcode	✓	
	Note : The New User Passcode must be different from all of the Passcodes currently in the lock.									
	CHANGE MASTER PASSCODE									
Press	Press	Press	Enter	Press	Enter same	Press	Enter	Press	Enter same	Press
✓	②	✓	Master passcode	✓	master passcode	✓	New master passcode	✓	New master passcode	✓
⚠ Note : The master code MUST EXIST in the lock and cannot be deleted, but can ONLY be changed.										
CHANGE USER PASSCODE										
Press	Press	Press	Enter	Press	Enter	Press	Enter	Press	Enter same	Press
✓	②	✓	Master passcode	✓	Unwanted user passcode	✓	New user passcode	✓	New user passcode	✓
Note : The New user passcode must be different from all of the passcodes currently in the lock.										
DELETE A USER PASSCODE										
Press	Press	Press	Enter	Press	Enter	Press				
✓	③	✓	Master passcode	✓	Unwanted user passcode	✓				
DELETE ALL USER PASSCODES										
Press	Press	Press	Enter	Press						
✓	④	✓	Master passcode	✓						
⚠ Note : The master code cannot be deleted, but can ONLY be changed.										

BEEPER	DISABLE BEEPER							The beeper can be turned off if desired. Beepers will still sound to indicate a low battery.	BEEPER
	Press	Press	Press	Enter	Press	Press	Press		
	✓	⑥	✓	Master passcode	✓	①	✓		
ENABLE BEEPER									
Press	Press	Press	Enter	Press	Press	Press			
✓	⑥	✓	Master passcode	✓	①	✓			

PASSAGE	EASY PASSAGE MODE					With EASY PASSAGE MODE active, the door will stay unlocked. Press any button to turn off this function when it is no longer needed.	PASSAGE
	Press	Press	Press	Enter	Press		
	✓	⑤	✓	Master passcode	✓		
ADVANCED PASSAGE MODE							
Press	Press	Press	Enter	Press	Press	Press	
✓	①	✓	Master passcode	✓	①	✓	
With ADVANCED PASSAGE MODE active,open the door by twisting door handle directly. Turn off this mode only by entering master code and check key. * Press the check button 4 times in a row , the door will be immediately locked, which overrides any working modes.							

ADVANCED	AUTO-LOCK MODE							In AUTO-LOCK MODE, the door will automatically lock after each unlocking, the auto-lock time depends on the setting of the auto-lock timer. * Press the check button 4 times in a row, the door will be immediately locked, which overrides any working modes.	ADVANCED
	Press	Press	Press	Enter	Press	Press	Press		
	✓	①	✓	Master passcode	✓	①	✓		
MANUAL-LOCK MODE									
Press	Press	Press	Enter	Press	Press	Press			
✓	①	✓	Master passcode	✓	②	✓			
SET AUTO-LOCK TIMER									
Press	Press	Press	Enter	Press	Press	Press	Enter	Press	
✓	⑨	✓	Master passcode	✓	③	✓	Auto-lock timer	✓	
The automatic lock time unit is seconds. Minimum is 2 seconds. Maximum is 43200 seconds (12 hours). Default is 4 seconds.									

REMOTE	ACTIVATE REMOTE CODE FEATURE							The activate code is generated by the website,(www.mylock.iulock.com) Deactivate remote code function when the activate code is 0.	REMOTE
	Press	Press	Press	Enter	Press	Enter	Press		
	✓	⑧	✓	Master passcode	✓	Activate code	✓		

Troubleshooting

www.iulock.com
24hr online service

The lock doesn't work?

Try replacing the battery or using the backup battery. If the lock still does not work, contact customer support.

Why can't I open the door?

You may be waiting too long to open the door. After entering a code, turn the handle to open the door while the lock LED indicator light is green. Once the LED indicator light is off, the lock will return to locked position immediately.

Why I can open without passcode?

You maybe active the passage mode, use master code access will turn off this function .

If you just installed it, make sure the "THIS SIDE UP" on the spindle is facing up (ceiling).

I forgot all my codes.

The lock must undergo a hard reset in order to set the master code back to default and erase all other codes. In order to perform a hard reset,please refer to the above "Restore Factory Settings".

If none of the above information resolves your issue, please visit our website at: www.iulock.com

Warranty

Lifetime Limited Mechanical and Finish Warranty and 1-Year Limited Electronics Warranty Subject to the terms and conditions of the warranty, IULOCK extends a lifetime limited mechanical and finish warranty and a one-year limited electronics warranty to the original consumer user ("Original User") of our IULOCK brand product ("Product") against defects in material and workmanship, as long as the Original User occupies the residential premises upon which the Product was originally installed. See answers www.iulock.com for specific warranty details and limitations

Important Safeguards

1. Read all instructions in their entirety.
2. Familiarize yourself with all warning and caution statements.
3. Remind all family members of safety precautions.
4. Protect your user passcode and master passcode.
5. Dispose of used batteries according to local laws and regulations.

⚠ WARNING :

This Manufacturer advises that no lock can provide complete security by itself. This lock maybe defeated by forcible or technical means. or evaded by entry elsewhere on the property. No lock can substitute for caution, awareness of your environment, and common sense. Builder's hardware is available in multiple performance grades to suit the application. In order to enhance security and reduce risk, you should consult a qualified locksmith or other security professional.

Template

