

# IULOCK

## IU-20 Smart door knob Installation and User Guide

### Lock Components

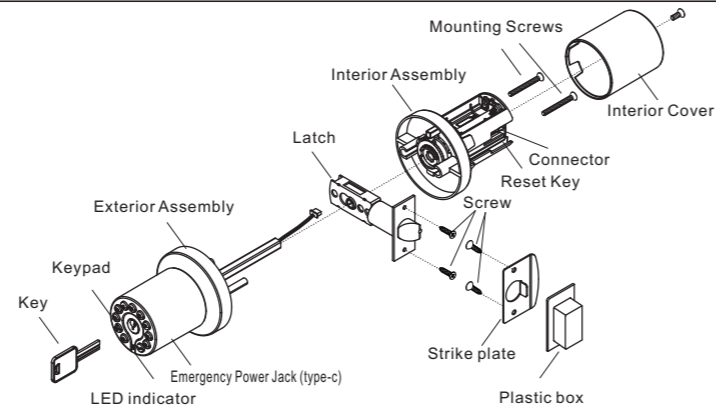

#### Required tools (not included)

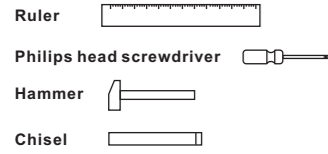

#### 4 AA alkaline batteries

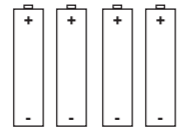

### 1. Prepare the door and check dimensions

#### Use template to mark holes

#### Drill two holes

#### Check dimensions

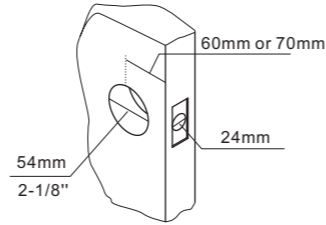
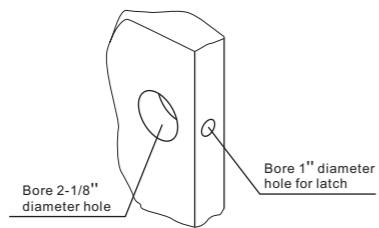
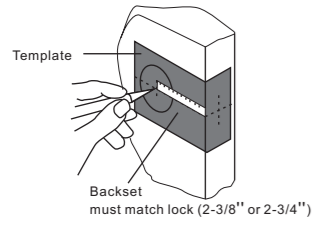

### 2. Install the latch and strike

#### Setting latch (60MM or 70MM)

#### Install latch

#### Install strike plate

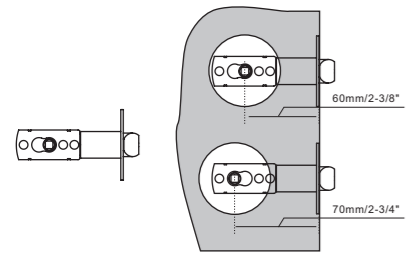

Adjust the latch to the distance you are going to install, 60 or 70mm (Backset 2-3/8" or 2-3/4")

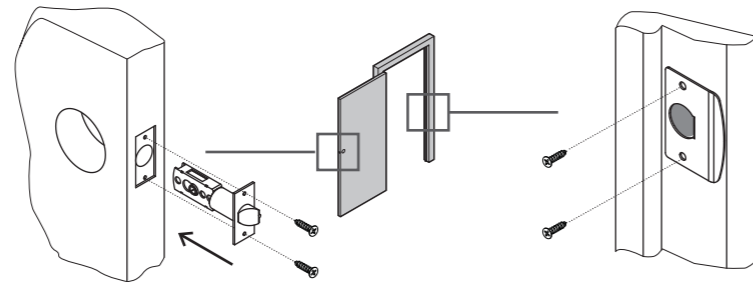

### 3. Install the exterior keypad and the interior assembly

#### Install the exterior keypad

#### Install the interior assembly

#### Push out the power cable with a screwdriver

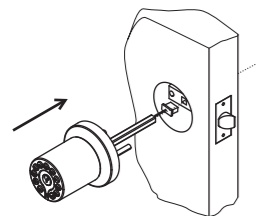

Align the exterior keypad with the bore hole. Feed the power cable through latch. The spindle on the exterior keypad should be aligned with the hole in the center of the latch. Insert the spindle through this hole as you press the exterior keypad against the door.

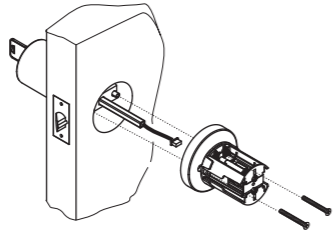

feed power cable through hole in knob and guide spindle into handle.

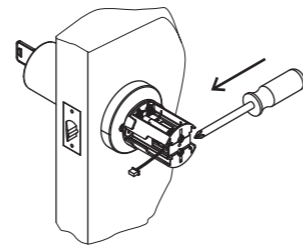

### 4. Install the batteries and perform the door handing process

### 5. Install the interior cover

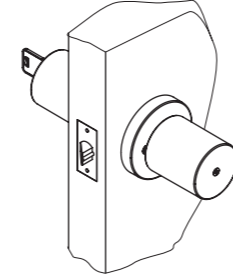
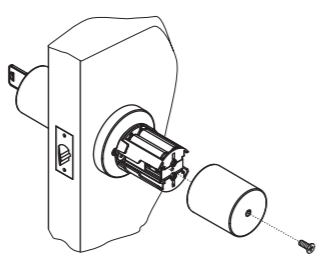
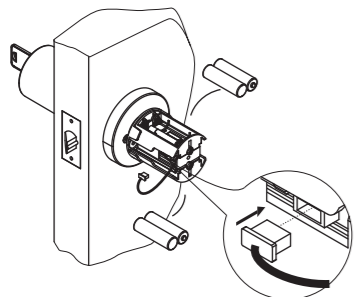

## Features

- . two ways to access: code and key
- . -30 to 80 °C temperature range
- . Low power consumption, 4 AA for 2 Years Battery Life or 20,000 times unlock
- . Backlit keypad for use in low light environments
- . 1 master code and 50 user codes
- . Passage mode for hassle-free entry
- . Color LED indicator lights up to show when codes and commands have been successfully entered
- . Built-in disguise feature to protect your codes from prying eyes
- . Low battery warning indication

## Programming guide

### Indicator light signals and beep

The color of the light indicates & beep ,the status of the lock.

#### Green

- . a correct master passcode or user passcode was entered ,one long beep
- . the programming process is complete ,one long beep

#### Red

- . an incorrect master passcode or user passcode was entered,three short beep
- . there was an error in programming, three short beep
- . red blinking and beep after keypad backlit off indicates critically low battery

## Passcode and Passcode Disguise

Control of the lock is simply 4-16 digit master passcode or 4-16 digit User passcode.

### Passcode Disguise

This function is an added security feature which is aimed at preventing passcode theft. With Passcode Disguise, you may enter 40 digits into the keypad. As long as the correct passcode sequence is entered, regardless of how many digits were entered before or afterwards, the lock will unlock. For example, if your user passcode is "112256", you can successfully unlock the lock by entering "xx...xx112256xx...x"(limit 40 digit).

## Master passcode

- . The lock comes preset with default master passcode 123456
- . Used to put the lock in programming mode.
- . Can unlock the lock
- . Must be different from all of the User Codes currently in the lock.
- . If you forget the master passcode, you can reset the lock to factory settings, which restores the default master passcode. See Restore Factory Settings

## User passcode

- . The lock comes not preset any User Code
- . Used to unlock the lock
- . Must be different from the master passcode and other user passcodes
- . Up to 50 possible User Codes can be stored in the lock at one time.

## Restore Factory Settings

To delete all user codes, including the master code, follow the instructions below:

1. Use a screwdriver to remove the screws from the interior cover.
2. Remove the cover and find the reset button located on the battery pack.
3. Press and hold the reset button for 7 seconds until long beep are heard. The master passcode will return to the manufacturer default code '123456'.

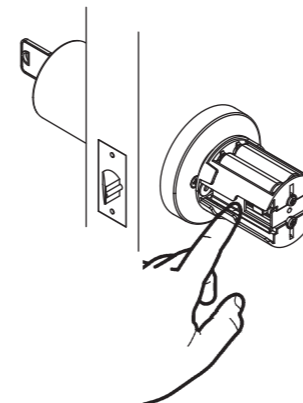

After restore factory , Change the master passcode as soon as possible! because of the master passcode can unlock the door.

## Keypad

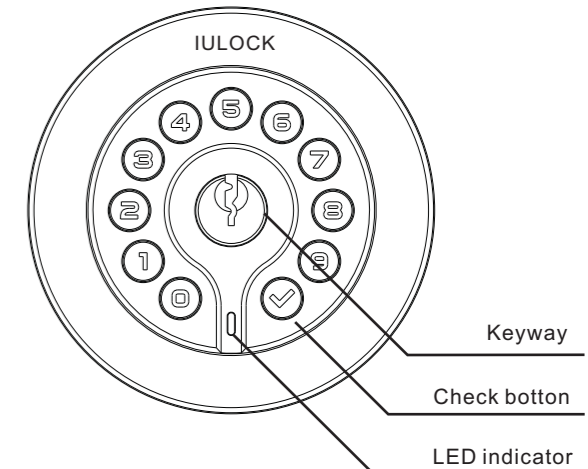

# Programming

»If you make a mistake during programming,press the check button repeatedly until the keypad lights up. Then start over.

ADDING USER PASSCODE								
Press	Press	Press	Enter	Press	Enter	Press	Enter same	Press
✓	1	✓	master passcode	✓	New user passcode	✓	New user passcode	✓

Note : The New User Passcode must be different from all of the Passcodes currently in the lock.

CHANGING THE MASTER PASSCODE & USER PASSCODE										
Press	Press	Press	Enter	Press	Enter	Press	Enter	Press	Enter same	Press
✓	2	✓	master passcode	✓	Old passcode	✓	New passcode	✓	New passcode	✓

Note : The New Passcode must be different from all of the Passcodes currently in the lock.

DELETING USER PASSCODE						
Press	Press	Press	Enter	Press	Enter	Press
✓	3	✓	master passcode	✓	unwanted user passcode	✓

DELETING ALL USER PASSCODE				
Press	Press	Press	Enter	Press
✓	4	✓	master passcode	✓

ENABLE PASSAGE MODE				
Press	Press	Press	Enter	Press
✓	5	✓	master passcode	✓

With this function active, you can open the door without requiring a passcode. press any key to turn off this function when it is no longer needed.

ENABLE BEEPER						
Press	Press	Press	Enter	Press	Press	Press
✓	6	✓	master passcode	✓	1	✓

DISABLE BEEPER						
Press	Press	Press	Enter	Press	Press	Press
✓	6	✓	master passcode	✓	0	✓

The beeper can be turned off if desired. Beeps will still sound to indicate a low battery.

# Troubleshooting

## Why is it beeping after keypad light off?

The battery may be low. Please replace the battery.

## The lock doesn't work?

Try replacing the battery or using the backup battery. If the lock still does not work, contact customer support.

## Why can't I open the door?

You may be waiting too long to open the door. After entering a code, turn the handle to open the door while the lock LED indicator light is green. Once the LED indicator light is off, the lock will return to locked position immediately.

## Why I can open without passcode?

You maybe open the passage mode, you can turn off this function by pressing any key.

## I forgot all my codes.

The lock must undergo a hard reset in order to set the master code back to default and erase all other codes. In order to perform a hard reset, you must have access to the back of the door.

If none of the above information resolves your issue, please visit our website at: [www.iulock.com](http://www.iulock.com)

# Warranty

Lifetime Limited Mechanical and Finish Warranty and 1-Year Limited Electronics Warranty Subject to the terms and conditions of the warranty, IULOCK extends a lifetime limited mechanical and finish warranty and a one-year limited electronics warranty to the original consumer user ("Original User") of our IULOCK brand product ("Product") against defects in material and workmanship, as long as the Original User occupies the residential premises upon which the Product was originally installed. See answers [www.iulock.com](http://www.iulock.com) for specific warranty details

# Important Safeguards

1. Read all instructions in their entirety.
2. Familiarize yourself with all warning and caution statements.
3. Remind all family members of safety precautions.
4. Protect your user passcode and master passcode.
5. Dispose of used batteries according to local laws and regulations.

## ⚠ WARNING:

This Manufacturer advises that no lock can provide complete security by itself. This lock maybe defeated by forcible or technical means. or evaded by entry elsewhere on the property. No lock can substitute for caution, awareness of your environment, and common sense. Builder's hardware is available in multiple performance grades to suit the application. In order to enhance security and reduce risk, you should consult a qualified locksmith or other security professional.

## Template

